

User s Manual

Catalog

❖	Installation notice	2
❖	Product Key Features.....	4
❖	Introduction to working mode	4
❖	Outward appearance	5
❖	DC wiring.....	8
❖	Battery connection example.....	8
❖	AC wiring	10
❖	FAN Operation.....	12
❖	Inverter connection diagram.....	12
❖	Hybrid inverter with solar controller connection diagram	13
❖	Solar panel and battery connection diagram.....	13
■	Solar panels in series	13
■	Batteries in series	13
■	Solar panel in parallel.....	14
■	Battery in parallel.....	14
❖	LED indicator and LCD introduction	14
■	LED indicator.....	15
■	LCD inf	16
■	LCD information.....	17
■	Hybrid solar input information.....	17
❖	parameter setting	18
❖	Fault code and repair	22
❖	buzzer alert	23
❖	Specifications	24

❖ Installation notice



Important Safety Instructions



Please save these instructions.

This manual contains important safety, installation, and operating instructions for the inverter, please read the product manual carefully before using this product.

- Check the package is complete before opening. After opening packing please check the accessories, The accessories includes 1PCS user manual and check the inverter is still protected well after transportation
- If you find damage or missing parts, please do not turn on the machine and contact your dealer.
- Please keep the packing box and materials for can be for next delivery if need.
- This series of products is very heavy, please handle it carefully .
- The inverter installation must be more than 30cm away from the wall, well ventilated, free of water, flammable gases and corrosives. As shown in the figure:

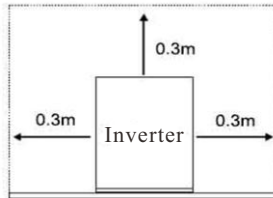

- Not good placed in a corner, side, or upside down, away from heat sources. To avoid direct sunlight, ensure that the front panel, rear panel, and fan inlets have good ventilation.
- The environment temperature should be between 0 ° C and 40 ° C.
- If the machine is disassembled and used in a low temperature environment, may happen water condense ,only can work till through dry of machine inside and outside ,otherwise will be shock risk
- Please install the inverter near the mains input socket or switch. It is easy to unplug the mains input or cut off the power supply when meet emergency situation..
- The external battery should not be exposed. It should be installed in the battery cabinet..
- The DC input between inverter should be short as possible
- Do not stack goods on the inverter.
- When the load is connected to the inverter, the load must be turned off before wiring, and The inverter is connected to a socket with over current protection, and the machine is safely grounded.
- The power outlet should be safely grounded.
- If need to make the inverter no output, must turn off all switches first, then turn off the mains power supply. Whether the inverter has input or not, MUST turning off the inverter does not ensure that the internal parts are not have power.

- Need to touch inductive load: when inductive load such as motor, display, laser printer. The inverter capacity is three times of the load equipment starting power .
- Need often to keep charging to extend battery life. When the inverter is connected to the normal mains, whether inverter is on or off, it still keep charging the battery, and provides overcharge protection.
- Normally, the battery life is three to five years. If there is a problem with the battery, it must be replaced early. When replacing the battery, it must be operated by professionals.
- It is not recommended to replace the battery individually. When replacing, should follow the battery supplier's operating instructions.
- **note:**
- Before replacing the battery, you must cut off all power connected to the machine: mains switch, battery switch, etc.
- Take off metal objects such as rings and watches.
- Use tool as handles and screwdrivers. Do not put tools or other metal objects on the battery.
- It is normal for a small spark when connecting the battery cable, but will not harm human safety and inverter.
- **Note: Do not short the battery positive and negative, can't connection reverse battery.**

◆ Inverter Safety

The inverters are suitable for Battery Banks ONLY.

Always make sure inverter is in OFF position and disconnect all AC and DC connecting when working on any circuit associated with the inverter. NEVER connect the AC output of the unit directly to an Electrical Breaker Panel/ Load Centre which is also fed from the utility power / generator. When connecting battery terminals, ensure the polarity of the battery connections is correct. Incorrect polarity may cause permanent damage to the unit. Be careful when touching bare terminals of capacitors as they may retain high lethal voltages even after power is removed.

◆ Battery Safety

Do NOT let the positive (+) and negative (-) terminals of the battery touch each other.

Use sealed Lead-Acid, Flooded, Gel, AGM, Lithium batteries which must be deep cycle.

Explosive battery gases may be present while charging. Be certain there is enough ventilation to release the gases.

Be careful when working with large lead acid batteries. Wear eye protection and have fresh water available in case there is contact with the battery acid.

Over-charging and excessive gas precipitation may damage the battery plates and activate material shedding on them. Too high of an equalizing charge or too long of one may cause damage. Please carefully review the specific requirements of the battery used in the system.

Installation Safety

The unit should be installed in a well-ventilated, cool, and dry environment. Make sure the fans of the unit and the ventilation holes are not blocked.

Do not expose the unit to rain, moisture, snow, or liquids of any type.

❖ Product Key Features

- Suitable for mains power unstable or often off, and important equipment that requires backup power.
- This product adopts high-precision DSP control chip, precise detection circuit、advanced control technology .
- Intelligent temperature-regulating fan, efficient heat dissipation, extending system life.
- Pure sine wave output, Multiple working mode options
- Multiple electronic protections: short circuit protection, overvoltage and under voltage protection, overload protection, Overheat / short circuit automatic restart(automatic restart three times)
- wide frequency and wide voltage input, can be used for diesel / gasoline generator input.
- 3-Stage battery charger with configurable charging current
- 8 Pre-Set battery voltages including Lithium; User-defined option

❖ Introduction to working mode

Work mode	Description
01 Mains priority	When the mains power is available, the mains power supply power to the load, and when the mains power is off, the battery will supply power to the load and charging to battery.
02 Energy saving mode	When the inverter is in battery priority mode and the output load is less than 1%-10% of the power(set by the P7 ,10% default), the AC output will be turn off, The inverter restarts every 1 minute, and checks whether the load is greater than the set power. When the connected load is greater than the minimum setting, the inverter restarts output. This function is to reduce the battery loss and extend the battery backup time.
03 Battery priority mode	The battery supply power to the load. When the battery voltage is lower than the set battery voltage(voltage set by PA item), use mains power supply power to the load. When the battery voltage is restored , the battery will supply power to the load again (When battery power is low or PV power is off inverter use mains power charging for battery or not set by PC) .
04 Mains priority unattended mode	Inverter automatically turn on when connected to mains power or battery voltage is normal (not include inverter first time use) . But when the battery discharge voltage lower than battery voltage by set F4 (F4: set the battery low voltage power is turn off), the power will be turned off. Inverter on only mains power is coming or turn on by hand.(mains is charging is or not set by PC)

<p>05 Battery priority unattended mode</p>	<p>When the battery voltage is normal ,the inverter automatically turn on and battery supply power to the load. When the battery is low voltage ,mains power supply power to the load. When the battery discharge to battery low voltage shutdown (PL setting), the inverter enters standby and waits for the mains power or solar charging to battery .When the battery voltage is restored (PN setting),the inverter automatically turn on .But when the battery discharge voltage is lower than battery voltage (set by F4), power will be turn off .Inverter on only mains power is coming or turn on by hand</p>
--	---

❖ Outward appearance

◆ Front panel

Inverter

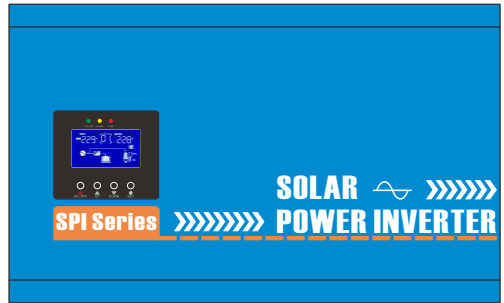
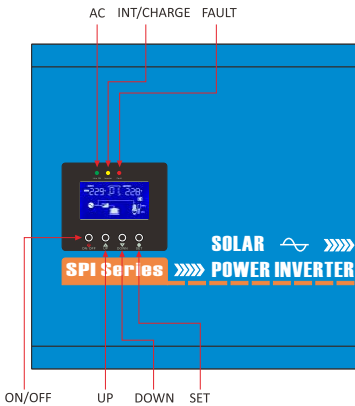

Hybrid inverter

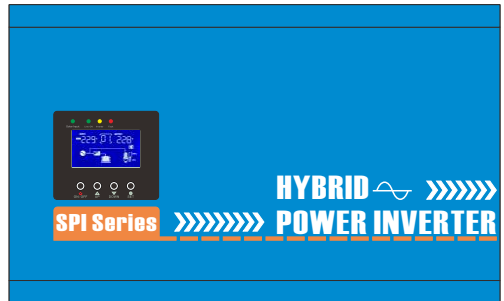
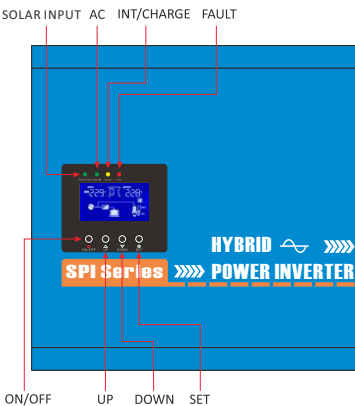

◆ inverter charger back panel

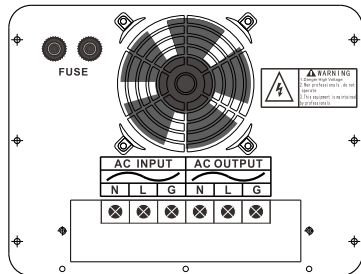
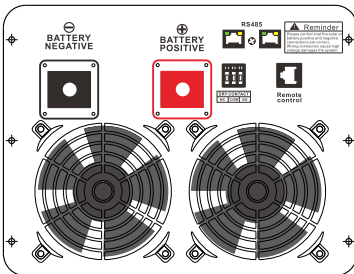
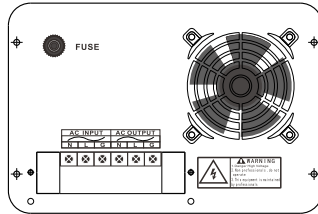
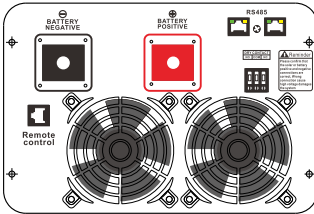
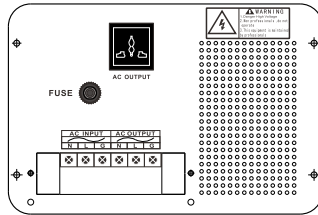
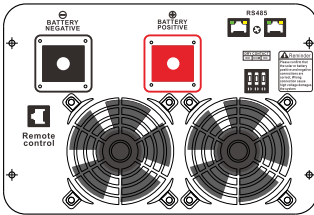
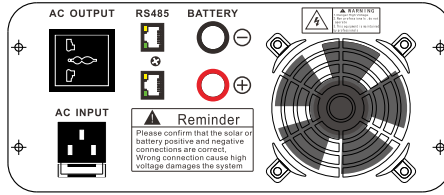

◆ Hybrid inverter with solar controller back panel

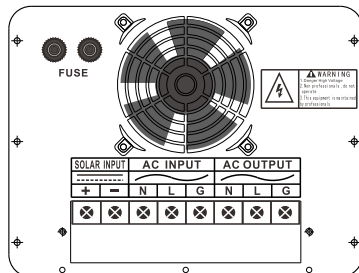
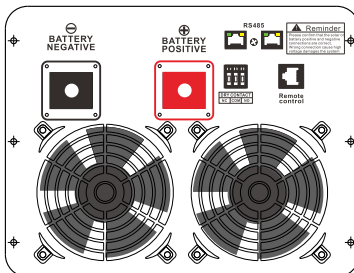
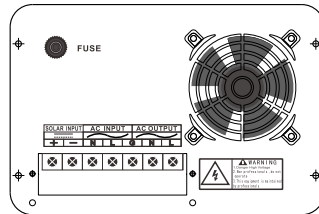
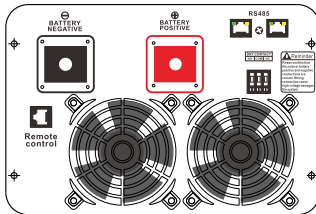
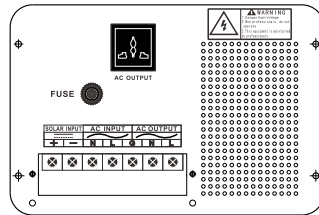
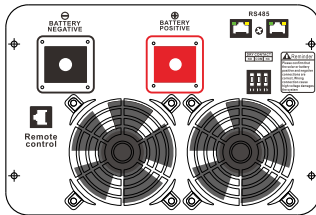
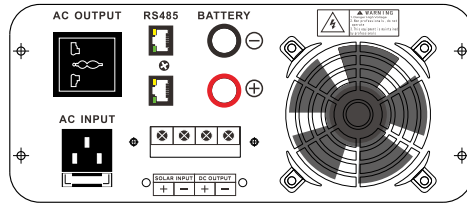

❖ DC wiring

WARNING

DC wiring not following the minimum DC requirement will cause irreversible damage to the unit.

CAUTION

Be careful of the positive and negative poles. Reversing the poles might cause permanent damage to the inverter. It will surely blow the internal fuse.

NOTE

Damage to the inverters due to reverse polarity is NOT covered by warranty.

NOTE

The input terminals of the inverters have large capacitors connected to them. Once a positive and negative wire are connected to the terminals, it will complete the circuit, and commence drawing a heavy current momentarily. As a result, there may be a sparking occurring even if the inverter is in the off position. To minimize sparking, it is recommended that the user have the appropriate size wire feeding into the inverters and/or install an external fuse leading into the inverter.

WARNING

Ensure all sources of DC power (i.e., batteries, solar, etc.) and AC power (utility power or AC generator) are de-energized (i.e., breakers opened, fuses removed) before proceeding —to prevent accidental shock.

1. Unscrew the screw terminals along the edge of the side plate
2. Gently remove DC Side plate to expose DC Terminals
3. Connect the positive and negative DC Cables to their respective terminals and run them through the side panel

WARNING

The Terminals must clean to reduce the resistance in the cable connection. A buildup of dirt or oxidation may eventually lead to the cable terminal overheating during periods of high current draw

- When installing DC cables, the following are recommendations:
 1. Battery positive and negative cables should be as close to the battery as possible to minimize voltage loss and other possible effects.
 2. Tie, tape, or twist cables together to reduce self-inductance.
 3. Install all overcurrent devices on the positive cable.

❖ Battery connection example

■ 12V connection diagram

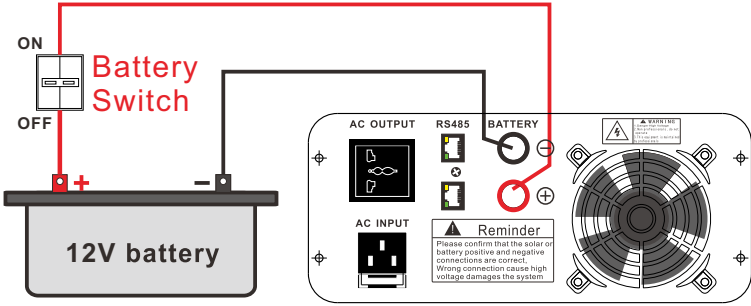

■ 24V connection diagram

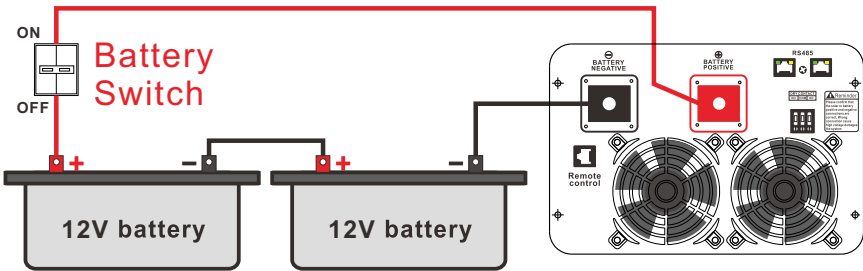

■ 48V connection diagram

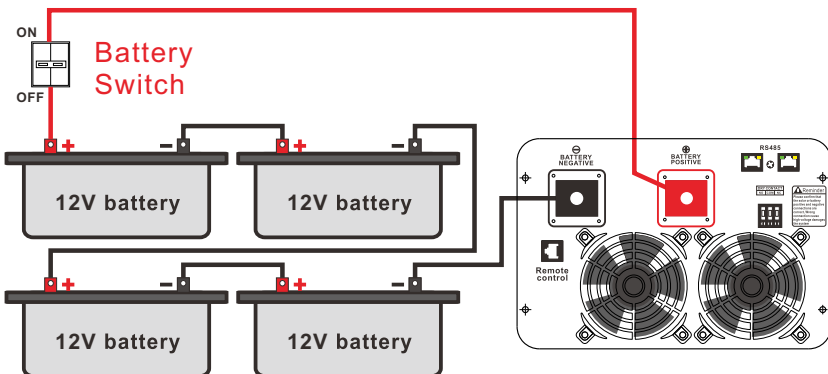

■ 96V connection diagram

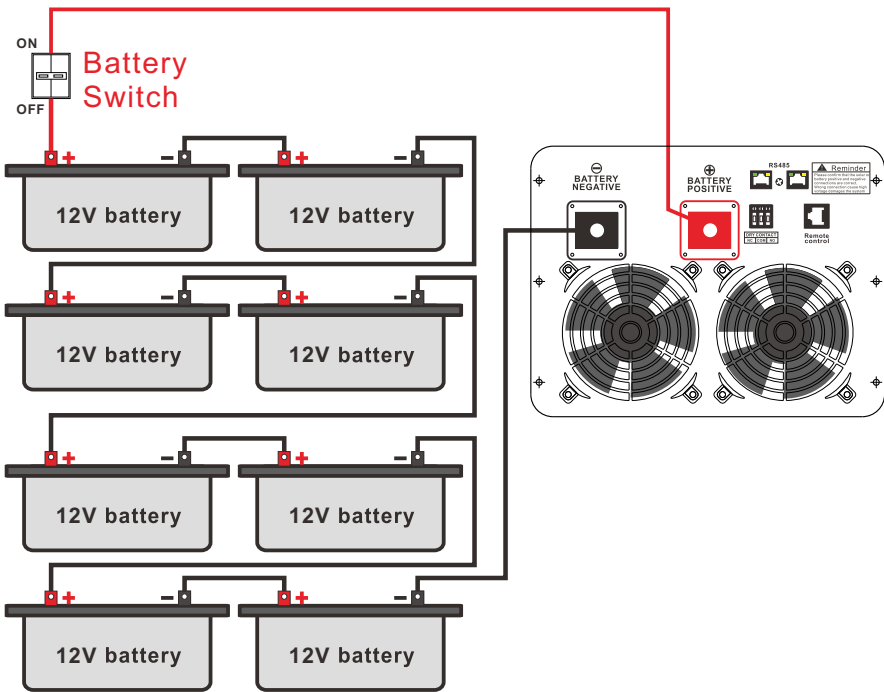

❖ AC wiring

CAUTION

Avoid switching on the inverter with the load (electronic devices) already switched on. This may trigger an overload since some electronic devices have an initial high power surge to start.

CAUTION

When switching off the inverter, turn off the electronic devices first. Although the inverter is off, the capacitors will still have a charge, so the DC and AC terminals must be disconnected if altering the circuitry.

CAUTION

Ensure all sources of DC power (i.e., batteries, solar, etc) and AC power (utility power or AC generator) are de-energized (i.e., breakers opened, fuses removed) before proceeding—to prevent accidental shock.

● Steps

1. Remove the AC Terminal block
2. Make note of the AC Input terminals from left to right (Neutral, Live, Ground).
and the AC output terminals from left to right (Neutral, Live, Ground).

* If you want to connect the inverter to diesel generator or gasoline generator, please follow these steps:

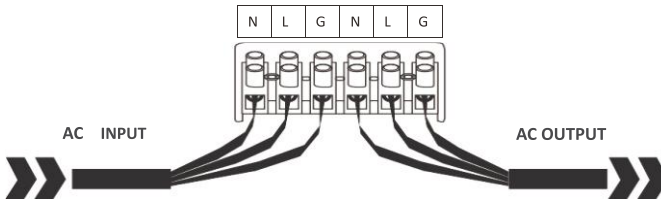

1. Turn on the generator, after it works stably, connect generator output to the inverter input(Confirm the inverter is no-load), then turn on the inverter as normal. After the inverter starts working, connect the load.
2. Recommended generator capacity is 2-3 times larger than the inverter.



The AC input must **NEVER** be connected to the AC output as irreversible overload or damage may result
AC Output should **NEVER** be connected to public power or a generator



This cannot be disabled.

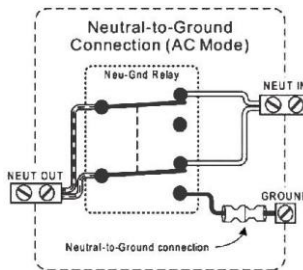

❖ Automatic Transfer Relay

The inverter chargers are equipped with a 30A transfer relay switch that switches between Inverter and Standby mode depending on availability of AC input power. If AC is present, the transfer relay bypasses up to 30A of the incoming AC power through the inverter to power the AC loads on the inverter’s output. In the event AC power gets disconnected, the inverter will power the loads through the battery bank.



The inverter’s internal AC transfer relay contacts are rated for 30 amps (each leg), the pass-through current for relay contact must be no greater than 30 amps or damage to this relay may occur.

❖ Dry Contacts for Auto Generator Start

- To use this to function, an auto start controller must be installed on the generator. there are three contacts; left to right: Normally Closed (NC) Common (COM), Normally Open(NO).
- When mains power is off ,inverter use battery power supply the load, dry contact auto start
- Do not store units with auto gen start feature enabled. Generators exhaust dangerous fumes when running.

❖ Auto Restart Temperature Fault

The operating temperature range for the inverter series is 0C°-40C° / 32F° - 104F°. If internal power components begin to exceed their safe operating temperature level, the inverter shuts down to protect itself from damage. need to manually restart when the inverter cools down .

❖ FAN Operation

By default, when first powering the unit the fans and alarm will run for approximately 1 minute as part of the start-up routine. Other fan ON/OFF operation parameters are listed below:

Condition	Turn on Condition	Turn off Condition
Inverter Charger Uptime	Uptime \leq 1 minute	Uptime $>$ 1 minute
Inverter Mode Load Percentage	Load \geq 50%	Load $<$ 50%
DC Input Current	Current \geq 10A	Current $<$ 6A
Inverter Heat Sink Temperature	Temperature \geq 50°C	Temperature $<$ 45°C

❖ Inverter connection diagram

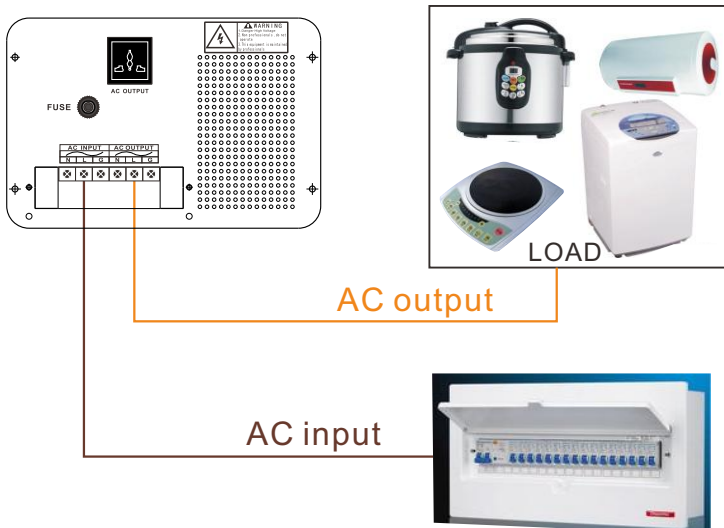

❖ Hybrid inverter with solar controller connection diagram

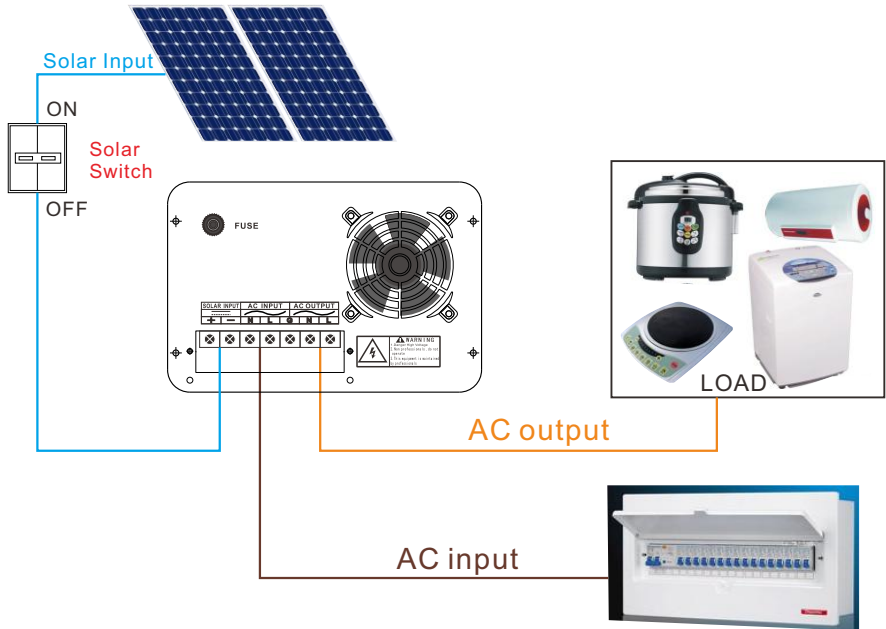

❖ Solar panel and battery connection diagram

■ Solar panels in series

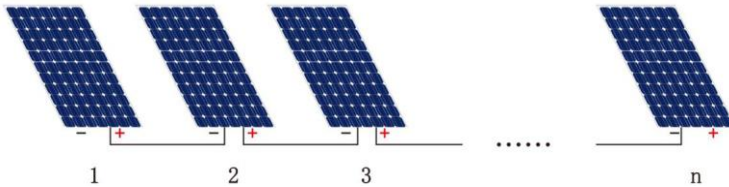

Solar panel voltage = $1 + 2 + 3 + \dots + n$, the voltages of each solar panel are added together.

■ Batteries in series

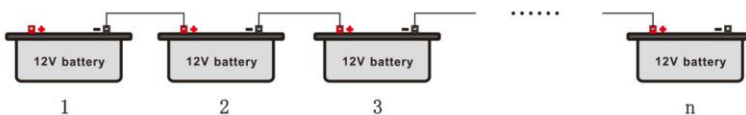

Battery voltage = $1 + 2 + 3 + \dots + n$, the voltages of each battery are added together.

■ Solar panel in parallel

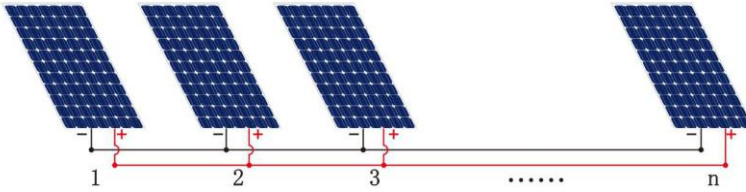

Solar panel voltage = 1 = 2 = 3 = ... n, the voltage of 1PCS solar panel (the voltage of each panel must be the same to be connected in parallel).

■ Battery in parallel

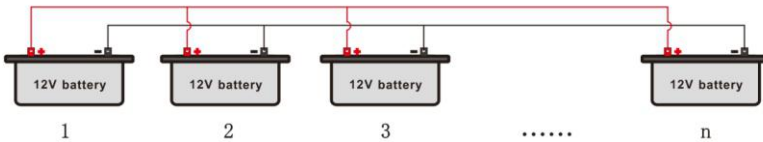

Battery voltage = 1 = 2 = 3 = ... n, the voltage of 1PCS battery (the voltage of each battery must be the same to be connected in parallel).

❖ LED indicator and LCD introduction





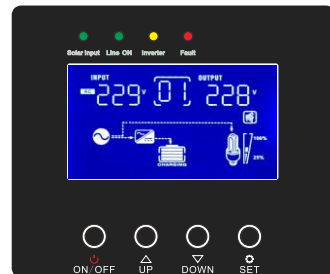





Inverter











Hybrid inverter

■ LED indicator











 Green Light (Solar input)	when has solar power input LED light will lighting , without solar power off LED light will off
 Green Light	In the mains working mode, the LED light is on when the mains is working, the green light off when the inverter is inverting.
 Yellow Light	<ol style="list-style-type: none"> 1. Solid Battery is fully charged or inverter mode In the 03 battery priority mode, the PC menu determines the light is on or off during charging. 2. Flashing Battery is charging mains charging indicator. (It will off when charging is completed).
 Red Light	<ol style="list-style-type: none"> 1. Flashing when the overload is more than 105%, lighting when the overload is more than 110%, lights flashing when the battery is low 2. Solid when the inverter fails.
 ON/OFF	Hold 3-5 seconds to turn on the inverter and buzzer will sound. Hold 3 seconds to turn off the inverter
 UP	 DOWN Press UP or DOWN to check LCD display parameters
 SET	<ol style="list-style-type: none"> 1. Press 3-5 seconds to enter the inverter setting page parameter, 2. Press to confirm setting in parameter setting

■ LCD inf





Load Information					
		Indicates overload.			
Indicates the load level by 0-25%, 26-50%, 51-75% and 76-100%					
		0%-25%	26%-50%	51%-75%	76%-100%
Mode Operation Information					
		Indicates unit is connected to shore power			
		Indicates load is supplied by utility power.			
		Indicates the utility charger circuit is working.			
		Indicates the DC/AC inverter circuit is working.			
Mute Operation					
		Indicates unit alarm is disabled.			

Battery Information	
Battery voltage	Battery capacity percentage
14.00V	100%
13.30V	100%
13.00V	90%
12.60V	80%
12.40V	70%
12.20V	60%
12.00V	50%
11.80V	40%
11.60V	30%
11.40V	20%
11.20V	10%
10.00V	0%

■ LCD information

	<p>No Inverter mode: No mains input, only connect to battery</p>		<p>Mains mode (battery capacity icon flashing when AC charging)</p>
	<p>03: Battery priority mode, mains status (mains icon will flash)</p>		<p>50Hz/60Hz: Frequency display(Automatic)</p>
	<p>LOAD***%: Load % display</p>		<p>LOAD***W: Load power display</p>
	<p>Overload display (Over Load icon will flashes)</p>		<p>BATT***%: Battery % display</p>
	<p>BATT**V: Battery voltage display</p>		<p>INV0.0KW: Inverter total output power display</p>

■ Hybrid solar input information

	<p>Solar input with mains</p>		<p>Solar input without mains</p>
	<p>PV***V : Solar input voltage display</p>		<p>PV***A Solar input current display</p>

❖ parameter setting

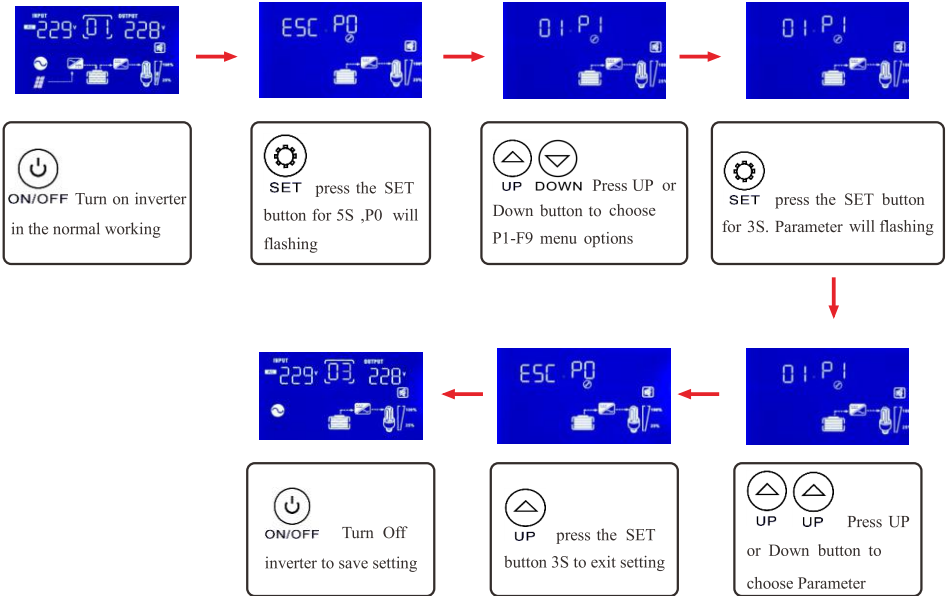

1. When the inverter in the normal working
2. press the **SET** button for 5S to enter the setting menu. Enter the setting menu, LCD shows the working mode icon is flashing.
3. Press the **UP** button or the **DOWN** button to operate the menu options. The working mode icon will change depending on the operation.
4. When choose the right menu option, press the setting button **SET** 3S to enter the setting parameters,(At this time, the working mode icon is not flashing, in the left parameter item is flashing.)
5. Press the up or down button to select the setting parameter, press the SET button 3S to exit the setting.(At this time, the working mode icon flashes, and the parameter icon does not flash.)
6. To exit the mode (**ESC**), press the **SET** button 3S to enter the set parameters and then press the **SET** button 3S to exit the setting menu and save the settings,
7. Need to press the ON/OFF button to save parameters Setting.

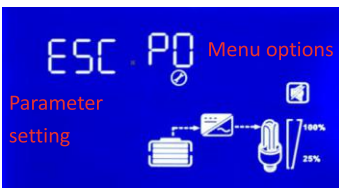

P0:Set work mode menu:

Press the SET button 3S to enter the setting menu, the menu selection icon is flashing. If need save and exit, press the SET button 3S to save and exit



P1: work mode setting:
01: Mains priority mode
02: Energy saving mode
03: Battery priority mode
04: Mains priority Unattended mode
05: Battery priority Unattended mode



P2: Battery type and charging voltage setting:
SLD: lead-acid battery (default), GEL: gel battery, LI: lithium battery, USE: user mode. Select USE user mode to adjust battery voltage in P3 and P4 menus. If you do not select the USE user mode, the P3 and P4 menus will not appear.



P3: Battery voltage uniform charge setting:
12.5V ~ 15.5V (single) can be set



P4: Battery voltage floating charge setting:
12.5 ~ 13.9 (single) can be set



P5: Maximum mains charging current setting:
(Default For details, refer to the label of the corresponding machine)
5A, 10A, 20A, 30A, 40A, 50A



P6: Buzzer sound setting:
ON: Turn on the buzzer, OFF: Turn off the buzzer (overvoltage, under voltage, overload, over temperature, except faults)



P7: Energy saving mode AC output setting:
(10% default), in (USE) user mode, can be adjusted up and down 1.0-10% / 1%



P8: Inverter output voltage setting:
AC220V:default 220V, (208V, 210V, 220V, 230V, 240V)
AC110V:default 110V, (104V, 105V, 110V, 115V, 120V)



P9: AC Output frequency setting:
50Hz default, (50Hz, 60Hz)



PA: battery priority mode battery under voltage to mains voltage setting:
10.5V default, (single section: 10.5V, 10.6V, 10.7V, 10.8V, 10.9V, 11.0V, 11.1V, 11.2V, 11.3V, 11.5V)



PB: battery priority mode, when battery voltage is restored inverter from city power conversion inverter voltage:
13.2V default, (single battery: 13.2V, 13.3V, 13.4V, 13.5V, 13.7V, 13.9V, 14.1V, 14.4V)



PC: battery priority mode, mains is charged or not:
AUT default, ON (battery priority with AC charging), OFF (battery priority without AC charging), Automatic (Only the inverter with built-in solar controller can make this function work, detection solar priority or city power priority, select solar charging, the mains will charge when the solar charging current is small) The specific charging method is as follows:

The relationship between solar charging and mains charging:	
Solar charging current	Mains charging current (* maximum set charging current)
40A	0%
30A	20%
20A	40%
10A	60%
5A	80%
0	100%



Pd: AC input lowest voltage setting:

AC220V:Default 160VAC, (140V, 150V, 160V, 170V, 180V)

AC110V:Default 80VAC, (70V, 75V, 80V, 85V, 90V)



PE: AC input highest voltage setting:

AC220V:Default 275V, (260V, 265V, 270V, 275V, 280V, 285V, 290V)

AC110V:Default 137V, (130V, 132V, 135V, 137V, 140V, 142V, 145V)

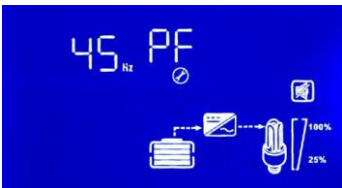

PF: AC input minimum frequency setting:

Default 45Hz, (40Hz, 41Hz, 42Hz, 43Hz, 44Hz, 45Hz)



PH: AC input maximum frequency setting:

Default 63Hz, (63Hz, 64Hz, 65Hz)



PL: Battery low voltage shutdown setting:

(must : Pn>PL>F4)

10.2V default, 9.5V ~ 12.0V (single) can be set



Pn: unattended mode, battery under voltage restores the startup voltage setting: **(must : Pn>PL>F4)**
 12.4V default, 11.0V ~ 13.0V (single) can be set



F3: Generator mode setting:
 Default OFF (ON \ OFF)



F4: Unattended mode battery voltage low power off power point setting: **(must : Pn>PL>F4)**
 Default single section 10.0V (9.0V-12.0V can be set)



F5: Fan failure detection settings:
 Default single block OFF (ON, OFF)



F9: Negative temperature detection setting:
 The default OFF, (ON, OFF) When the temperature is below -15 °C use the machine, please turn on this setting (ON)

❖ Fault code and repair

- ◆ This icon  will flash when there is a fault.

it will flash when there is a fault.



Fault code display

Cause	Buzzer or indicator	Fault cause	Solution
E01		Battery low voltage	Check the battery is broken or not
E02	1 long 2 short B-BB shout, red light is off	Battery overvoltage	Check the battery is broken or not
E03	Buzzer urgent shouting, the red light lighting	Battery low voltage	Check the battery is broken or not
E04	Intermittent ringing, red light is off	Transformer secondary line reverse connection	Restart or contact the supplier
E05	Keep shouting, red light keep lighting	Inverter startup failure	Check output have short circuit, overload or not
E06	Keep shouting, red light keep lighting	Output for short circuit	Check output have short circuit, overload or no
E07	Keep shouting, red light keep lighting	Output voltage is too low or overloaded	Check output voltage and load
E08	Keep shouting, red light keep lighting	Temperature is too high	Check the fan is working
E09	Output Low voltage		
E11	Keep shouting, red light keep lighting	Low temperature or temperature control failure	Check the temperature control lines are not open circuit , dropped
E14	Keep shouting, red light off	Fan open circuit	Check the fan are not open circuit , dropped
E15		Input relay short circuit	Tap the input relay to check it broken or not
ES0	Displayed when press the controller display page	Controller work well	Controller work well
ES3	Displayed when press the controller display page	Controller over current	Internal fault
ES4	Displayed when press the controller display page	Controller temperature high	Internal fault
ES5	Displayed when press the controller display page	Solar input overvoltage	Check Solar input voltage and correct number of solar panels
ES6	Displayed when press the controller display page	Solar input low voltage	Check Solar input voltage and solar panels not have damaged

❖ buzzer alert

Buzzer sound:

- 1) Inverter: A beep sounds every 10 seconds. 10S --- 10S ---
- 2) When the battery voltage is low, one sound per second. --1S--1S--
- 3) When the battery is high voltage: three sound every four seconds, one long and two short. 4S -----
- 4) Overload:
 - > 110% long sound. ----
 - > 105% sound every two seconds. 2S --- 2S ---
- 5) Temperature control failure: 2 sound every 4 seconds 4S-- --4S---
- 6) The temperature is too high: sound every two seconds. 2 --- 2 ---
- 7) Fan abnormality: long sound ---

❖ Specifications

Inverter Specifications					
Model	500W	700W	1000W	1200W	1500W
Surge Power (1 second)	1500W	2100W	3000W	3600W	4500W
Surge Power (10 seconds)	650W	910W	1300W	1560W	1950W
Surge Power(60seconds)	550W	770W	1100W	1320W	1650W
Commercial Power Range	110VAC,115VAC,120VAC,220VAC,230VAC,240VAC(Optional)				
AC Frequency Range	45-65HZ				
AVR Voltage Range (VAC)	110VDC,115VAC120VAC,220VAC,230VAC,240VAC±10% (Auto-sensing)				
Output Frequency Range(AC mode)	Tracking automatically /shared frequency with the commercial inversion state:60/50±0.5 Hz				
DC Voltage Input	12VDC /24VDC				
Input Wave Form	Sine Wave (Utility or Generator)				
Output Wave Form	Pure Sine Wave				
Output Overload	105% < Load < 110% ± 10% : Fault (Turn off output after 60 seconds) 110% < Load < 130% ± 10% : Fault (Turn off output after10 seconds) 150% < Load ± 10% : Fault (Turn off output after 1 seconds)				
Thermal Method	cooling fan in intelligent control is≤42 °C, fan rotates slowly to ≥ 45 °C or the load is ≥ 50%, and the fan rotates fast				
Communication port	RS485/WIFI (Optional)				
temperature	-10°C ~+50°C				
Humidity	10%~90%				
Short Circuit Protection	Software Protection				
Line Mode Efficiency	> 95%				
Optimal Efficiency	>85%				

DC Battery Specifications						
Model		500W	700W	1000W	1200W	1500W
AC Charging(Max)	12VDC	10A	30A	30A	30A	30A
	24VDC	5A	20A	30A	30A	30A
Battery Type		GEL, AGM, SLA, FLD, LI, USER (default SLA)				
Input Voltage Range		12VDC:10.5-15V		24VDC:21-30V		
Floating Charge Set		12VDC:12.9 ~ 13.6 V		24VDC:25.8 ~ 27.2V		
Low Voltage Restored		12VDC:12.6-14.4V		24VDC:25.2-28.8V		
Low Voltage Shutdown set		12VDC:10-10.9V		24VDC:20-21.8V		
Over Voltage Protection		12VDC:16.7V		24VDC:33.4V		
Over Voltage Alarm		12VDC:15V		24VDC:30V		
Transfer Time		Typical: 5-8ms(Including detection time)				
Waveform		Pure sine wave				

solar charge controller						
Model		500W	700W	1000W	1200W	1500W
Max Solar Charger Current		PWM: 12V/24V: 60A (Max), MPPT:12V/24V: 40A (Max)				
Battery DC Voltage		12VDC/24VDC				
PV Voltage Input Range		12V:12-25VDC(PWM),24V:24-50VDC(PWM)				
		12V:15-90VDC(MPPT), 24V:30-90VDC(MPPT)				
Max PV Power Input		12V:10A:120W,20A:240W,30A:360W,40A:480W,50A:600W,60A:720W				
		24V:10A:240W,20A:480W,30A:720W,40A:960W,50A:1200W,60A:1440W				

Inverter Specifications

Model	700VA	1000VA	1500VA	1800VA	2000VA
Surge Power (1 second)	2100VA	3000VA	4500VA	4800VA	6000VA
Surge Power (10 seconds)	910VA	1300VA	1950VA	2340VA	2600VA
Surge Power(60seconds)	770VA	110VA	1100W	1980VA	2200VA
Commercial Power Range	110VAC,115VAC,120VAC,220VAC,230VAC,240VAC(Optional)				
AC Frequency Range	45-65HZ				
AVR Voltage Range (VAC)	110VDC,115VAC120VAC,220VAC,230VAC,240VAC±10% (Auto-sensing)				
Output Frequency Range(AC mode)	Tracking automatically /shared frequency with the commercial inversion state:60/50±0.5 Hz				
DC Voltage Input	12VDC /24VDC				
Input Wave Form	Sine Wave (Utility or Generator)				
Output Wave Form	Pure Sine Wave				
Output Overload	105% < Load < 110% ± 10% : Fault (Turn off output after 60 seconds) 110% < Load < 130% ± 10% : Fault (Turn off output after10 seconds) 150% < Load ± 10% : Fault (Turn off output after 1 seconds)				
Thermal Method	cooling fan in intelligent control is≤42 °C, fan rotates slowly to ≥ 45 °C or the load is ≥ 50%, and the fan rotates fast				
Communication port	RS485/WIFI (Optional)				
temperature	-10°C ~+50°C				
Humidity	10%~90%				
Short Circuit Protection	Software Protection				
Line Mode Efficiency	> 95%				
Optimal Efficiency	>85%				

DC Battery Specifications						
Model(1)		700VA	1000VA	1500VA	1800VA	2000VA
AC Charging(Max)	12VDC	10A	30A	30A	30A	30A
	24VDC	5A	20A	30A	30A	30A
Battery Type		GEL, AGM, SLA, FLD, LI, USER (default SLA)				
Input Voltage Range		12VDC:10.5-15V		24VDC:21-30V		
Floating Charge Set		12VDC:12.9 ~ 13.6 V		24VDC:25.8 ~ 27.2V		
Low Voltage Restored		12VDC:12.6-14.4V		24VDC:25.2-28.8V		
Low Voltage Shutdown set		12VDC:10-10.9V		24VDC:20-21.8V		
Over Voltage Protection		12VDC:16.7V		24VDC:33.4V		
Over Voltage Alarm		12VDC:15V		24VDC:30V		
Transfer Time		Typical: 5-8ms(Including detection time)				
Waveform		Pure sine wave				

solar charge controller					
Model	700VA	1000VA	1500VA	1800VA	2000VA
Max Solar Charger Current	PWM: 12V/24V: 60A (Max), MPPT:12V/24V: 40A (Max)				
Battery DC Voltage	12VDC/24VDC				
PV Voltage Input Range	12V:12-25VDC(PWM),24V:24-50VDC(PWM)				
	12V:15-90VDC(MPPT), 24V:30-90VDC(MPPT)				
Max PV Power Input	12V:10A:120W,20A:240W,30A:360W,40A:480W,50A:600W,60A:720W				
	24V:10A:240W,20A:480W,30A:720W,40A:960W,50A:1200W,60A:1440W				

Inverter Specifications

Model	2000W	3000W	4000W	5000W	6000W	7000W	8000W	10000W	12000W
Surge Power (1 second)	6000W	9000W	12000W	15000W	18000W	21000W	24000W	30000W	36000W
Surge Power (10 seconds)	2600W	3900W	5200W	6500W	7800W	9100W	10400W	13000W	15600W
Surge Power (60seconds)	2200W	3300W	4400W	5500W	6600W	7700W	8800W	11000W	13200W
Commercial Power Range	110VAC,115VAC,120VAC,220VAC,230VAC,240VAC(Optional)								
AC Frequency Range	45-65HZ								
Selectable Voltage range(VAC)	110VAC,115VAC,120VAC±10% (Auto-sensing)				110/115VAC:80-137VAC,120VAC:90-150VAC				
	220VAC,230VAC,240VAC±10% (Auto-sensing)								220/230VAC:160-275VAC, 240VAC:180-290VAC
Output Frequency Range(AC mode)	Tracking automatically /shared frequency with the commercial inversion state:60/50±0.5 Hz								
DC Voltage Input	12VDC/24VDC/48VDC				24VDC/48VDC/96VDC				48VDC/96VDC
Input Wave Form	Sine Wave (Utility or Generator)								
Output Wave Form	Pure Sine Wave								
Output Overload	105% < Load < 110% ± 10% : Fault (Turn off output after 60 seconds)								
	110% < Load < 130% ± 10% : Fault (Turn off output after 10 seconds)								
	150% < Load ± 10% : Fault (Turn off output after 1 seconds)								
Thermal Method	cooling fan in intelligent control is ≤42 ℃ , fan rotates slowly to ≥ 45 ℃ or the load is ≥ 50%, and the fan rotates fast								
Communication port temperature	RS485/WIFI (Optional) -10℃ ~ +50℃								
Humidity	10% ~ 90%								
Short Circuit Protection	Software Protection								
Line Mode Efficiency	> 95%								
Optimal Efficiency	>85%								

DC Battery Specifications										
Model	2000W	3000W	4000W	5000W	6000W	7000W	8000W	10000W	12000W	12000W
AC Charging(Max)	12VDC	30A	/	/	/	/	/	/	/	/
	24VDC	40A	40A	50A	50A	50A	/	/	/	/
	48VDC	20A	30A	40A	50A	50A	50A	50A	50A	50A
	96VDC	/	10A	20A	20A	20A	30A	30A	40A	40A
Battery Type: GEL, AGM, SLA, FLD, LI, USER (default SLA)										
Input Voltage Range	12VDC:10.5 ~ 15V		24VDC:21 ~ 30V		48VDC:41 ~ 60V		96VDC:82 ~ 120V			
Floating Charge Set	12VDV:12.9 ~ 13.6V		24VDC:25.8 ~ 27.2V		48VDC:51.6 ~ 54.4V		96VDC:103.2 ~ 108.8V			
Low Voltage Restored	12VDC:12.6 ~ 14.4V		24VDC:25.2 ~ 28.8V		48VDC:50.4 ~ 57.6V		96VDC:100.8 ~ 115.2V			
Low Voltage Shutdown set	12VDC:10 ~ 10.9V		24VDC:20 ~ 21.8V		48VDC:40 ~ 43.6V		96VDC:80 ~ 87.2V			
Over Voltage Protection	12VDC:16.7V		24VDC:33.4V		48VDC:66.8V		96VDC:133.6V			
Over Voltage Alarm	12VDC:15V		24VDC:30V		48VDC:60V		96VDC:120V			
Transfer Time	Typical: 5-8ms(Including detection time)									
Waveform	Pure sine wave									

solar charge controller										
Model	2000W	3000W	4000W	5000W	6000W	7000W	8000W	10000W	12000W	12000W
Max Solar Charger Current	PWM:60A(Max),MPPT:100A(Max)									
Battery DC Voltage	12VDC/24VDC		12VDC/24VDC/48VDC		24VDC/48VDC/96VDC		48VDC/96VDC		MPPT:150A(Max)	
PV Voltage Input Range	PWM:12V:25V,24:50V,48:75V,96V:145V(Max) MPPT:12V/24V(20-40A):90V,12V/24V(50-100A):130V,48V:(30A-100A)160V(Max) 48V(120-150A):180V,96V(50-60A):180V,96V(80-150A):280V(Max)									
Max PV	10A:120W,20A:240W,30A:360W,40A:480W,50A:600W,60A:720W,80A:960W,100A:1200W(Max)									
Power Input	10A:240W,20A:480W,30A:720W,40A:960W,50A:1200W,60A:1440W,80A:1920W,100A:2400W(Max)									
	10A:480W,20A:960W,30A:1440W,40A:1920W,50A:2400W,60A:2880W,80A:3840W,100A:4800W,120A:5760W,150A:7200W(Max)									
	30A:2880W,40A:3840W,50A:4800W,60A:5760W,80A:7680W,100A:9600W,120A:11520W,150A:14400W(Max)									

Inverter Specifications

Model	3000VA	5000VA	6000VA	7000VA	8000VA	10000VA	12000VA	15000VA	18000VA
Surge Power (1 second)	9000VA	15000VA	18000VA	21000VA	24000VA	30000VA	36000VA	45000VA	54000VA
Surge Power (10 seconds)	3900VA	6500VA	7800VA	9100VA	10400VA	13000VA	15600VA	19500VA	23400VA
Surge Power (60seconds)	3300VA	5500VA	6600VA	7700VA	8800VA	11000VA	13200VA	16500VA	19800VA
Commercial Power Range	110VAC,115VAC,120VAC,220VAC,230VAC,240VAC(Optional)								
AC Frequency Range	45-65HZ								
Selectable Voltage range(VAC)	110VAC,115VAC,120VAC±10% (Auto-sensing)					110/115VAC:80-137VAC,120VAC:90-150VAC			
Output Frequency Range(AC mode)	220VAC,230VAC,240VAC±10% (Auto-sensing) 220/230VAC:160-275VAC, 240VAC:180-290VAC								
DC Voltage Input	Tracking automatically /shared frequency with the commercial inversion state:60/50±0.5 Hz								
Input Wave Form	12VDC/24VDC/48VDC					24VDC/48VDC/96VDC			
Output Wave Form	Pure Sine Wave								
Output Overload	105% < Load < 110%±10% : Fault (Turn off output after 60 seconds) 110% < Load < 130%±10% : Fault (Turn off output after 10 seconds) 150% < Load ± 10% : Fault (Turn off output after 1 seconds)								
Thermal Method	cooling fan in intelligent control is≤42 ℃, fan rotates slowly to ≥ 45 ℃ or the load is ≥ 50%, and the fan rotates fast								
Communication port temperature	RS485/WIFI (Optional) -10℃~+50℃								
Humidity	10%~90%								
Short Circuit Protection	Software Protection								
Line Mode Efficiency	> 95%								
Optimal Efficiency	>85%								

DC Battery Specifications										
AC Charging(Max)	12VDC	3000VA	5000VA	6000VA	7000VA	8000VA	10000VA	12000VA	15000VA	18000VA
	24VDC	30A	40A	/	/	/	/	/	/	/
	24VDC	40A	40A	50A	50A	50A	/	/	/	/
	48VDC	20A	30A	40A	50A	50A	50A	50A	50A	50A
	96VDC	/	10A	20A	20A	20A	30A	30A	40A	40A
Battery Type GEL, AGM, SLA, FLD, LI, USER (default SLA)										
Input Voltage Range		12VDC:10.5 ~ 15V		24VDC:21 ~ 30V		48VDC:41 ~ 60V		96VDC:82 ~ 120V		
Floating Charge Set		12VDV:12.9 ~ 13.6V		24VDC:25.8 ~ 27.2V		48VDC:51.6 ~ 54.4V		96VDC:103.2 ~ 108.8V		
Low Voltage Restored		12VDC:12.6 ~ 14.4V		24VDC:25.2 ~ 28.8V		48VDC:50.4 ~ 57.6V		96VDC:100.8 ~ 115.2V		
Low Voltage Shutdown set		12VDC:10 ~ 10.9V		24VDC:20 ~ 21.8V		48VDC:40 ~ 43.6V		96VDC:80 ~ 87.2V		
Over Voltage Protection		12VDC:16.7V		24VDC:33.4V		48VDC:66.8V		96VDC:133.6V		
Over Voltage Alarm		12VDC:15V		24VDC:30V		48VDC:60V		96VDC:120V		
Transfer Time		Typical: 5-8ms(Including detection time)								
Waveform		Pure sine wave								
solar charge controller										
Model	3000VA	5000VA	6000VA	7000VA	8000VA	10000VA	12000VA	15000VA	18000VA	
	PWM:60A(Max),MPPT:100A(Max)									
Battery DC Voltage		12VDC/24VDC	12VDC/24VDC/48VDC	24VDC/48VDC/96VDC		MPPT:150A(Max) 48VDC/96VDC				
PV Voltage Input Range		PWM:12V:25V;24:50V;48:75V;96V:145V(Max) MPPT:12V/24V(20-40A):90V;12V/24V(50-100A):130V;48V(30A-100A)160V(Max) 48V(120-150A):180V;96V(50-60A):180V;96V(80-150A):280V(Max)								
Max PV Power Input	12VDC System	10A:120W,20A:240W,30A:360W,40A:480W,50A:600W,60A:720W,80A:960W,100A:1200W (Max)								
	24VDC System	10A:240W,20A:480W,30A:720W,40A:960W,50A:1200W,60A:1440W,80A:1920W,100A:2400W(Max)								
96VDC System	48VDC System	10A:480W,20A:960W,30A:1440W,40A:1920W,50A:2400W,60A:2880W,80A:3840W,100A:4800W,120A:5760W,150A:7200W(Max)								
	96VDC System	30A:2880W,40A:3840W,50A:4800W,60A:5760W,80A:7680W,100A:9600W,120A:11520W,150A:14400W(Max)								